

Antenna Basics

White Paper

This white paper describes the basic functionality of antennas. Starting with Hertz's Antenna model followed by a short introduction to the fundamentals of wave propagation, the important general characteristics of an antenna and its associated parameters are explained.

A more detailed explanation of the functionality of some selected antenna types concludes this white paper.



Table of Contents

1	Introduction	3
2	Fundamentals of Wave Propagation	5
2.1	Maxwell's Equations.....	5
2.2	Wavelength.....	6
2.3	Far Field Conditions.....	7
2.4	Free Space Conditions.....	7
2.5	Polarization.....	8
3	General Antenna Characteristics	9
3.1	Radiation Density.....	9
3.2	Radiation Pattern.....	10
3.3	Directivity.....	13
3.4	Gain.....	13
3.5	Practical Gain.....	14
3.6	Effective Area.....	14
3.7	Input Impedance.....	14
3.8	Nominal Impedance.....	15
3.9	Impedance Matching and VSWR.....	15
3.10	Antenna Factor.....	18
3.11	Bandwidth of an Antenna.....	19
4	Basic Characteristics of Selected Antennas	20
4.1	Half-wave Dipole.....	20
4.2	Monopole Antenna.....	22
4.3	Directional Antennas.....	24
4.4	Log-Periodic Dipole Antenna.....	25
4.5	Active Antennas.....	28
5	Appendix	31
5.1	References.....	31

1 Introduction

Antennas act as converters between conducted waves and electromagnetic waves propagating freely in space (see [Figure 1](#)). Their name is borrowed from zoology, in which the Latin word antennae is used to describe the long, thin feelers possessed by many insects.

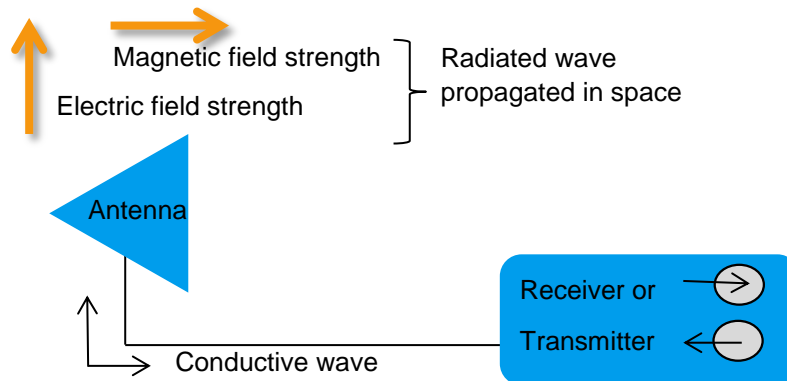

Figure 1: Basic antenna functionality

The oldest existing antennas, such as those used by Heinrich Hertz in 1888 during his first experiments to prove the existence of electromagnetic waves, were in theory and in practice not so very different from an RF generator.

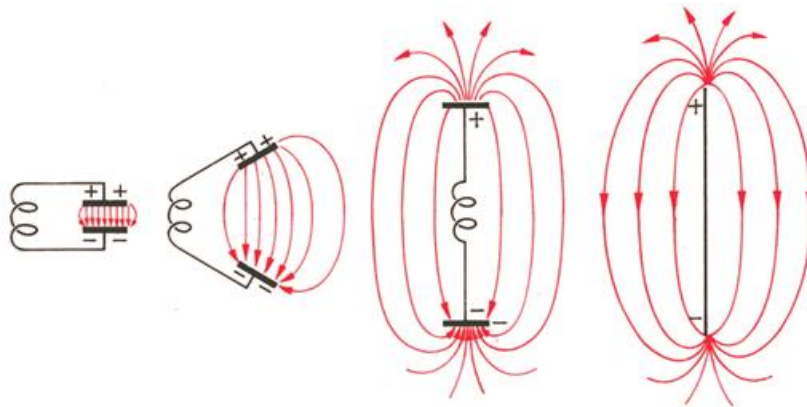

Figure 2: Heinrich Hertz's antenna model

An antenna can be derived from a parallel circuit which consists of an inductor and a capacitor. If the plates of the capacitor are bent open, and the inductor is reduced to the inductance of the wire itself, one ends up with a dipole antenna as shown at the very right position of [Figure 2](#).

In fact, resonant circuits are still frequently used even today as a means of explaining the individual properties of antennas. It was not until around 1900 or even later, when transmitting and receiving stations were being built, that a clear distinction was made and antennas were classified as separate components of radio systems.

In [Figure 3](#) it can be seen that the antenna is an important element in any radio system because it acts like a link of a chain. So the overall performance is significantly influenced by the performance of transmit and receive antennas.



Figure 3: Block diagram of a radio link

At first glance, modern antennas may still look very similar to the ancient model. However they are nowadays optimized at great expense for their intended application. Communications antenna technology primarily strives to transform one wave type into another with as little loss as possible.

This requirement is less important in the case of test antennas, which are intended to provide a precise measurement of the field strength at the installation site to a connected test receiver; instead, their physical properties need to be known with high accuracy.

The explanation of the physical parameters by which the behavior of each antenna can be both described and evaluated is probably of wider general use; however the following chapters can describe only a few of the many forms of antenna that are in use today.

2 Fundamentals of Wave Propagation

2.1 Maxwell's Equations

The equations postulated by the Scottish physicist James Clerk Maxwell in 1864 in his article *A Dynamic Theory of the Electromagnetic Field* are the foundations of classical electrodynamics, classical optics and electric circuits. This set of partial differential equations describes how electric and magnetic fields are generated and altered by each other and by the influence of charges or currents.

$$\operatorname{rot} \vec{H} = \vec{j} + \frac{\partial \vec{D}}{\partial t} \quad (1)$$

$$\operatorname{rot} \vec{E} = -\frac{\partial \vec{B}}{\partial t} \quad (2)$$

$$\operatorname{div} \vec{B} = 0 \quad (3)$$

$$\operatorname{div} \vec{D} = \rho \quad (4)$$

where rot (or *curl*) is a vector operator that describes the rotation of a three-dimensional vector field,

\vec{j} is the current density vector,

$\partial \vec{D} / \partial t$ is the time derivative of the electric displacement vector \vec{D} ,

$\partial \vec{B} / \partial t$ is the time derivative of the magnetic induction vector \vec{B} ,

$\operatorname{div} \vec{D}$ is the so called source density and ρ is the charge density.

Equation (1) is Ampere's law. It basically states that any change of the electric field over time causes a magnetic field. Equation (2) is Faraday's law of induction, which describes that any change of the magnetic field over time causes an electric field. The other two equations relate to Gauss's law. (3) states that any magnetic field is solenoid and (4) defines that the displacement current through a surface is equal to the encapsulated charge.

From Maxwell's equations and the so called **material equations**

$$\vec{D} = \varepsilon \cdot \vec{E} \quad \vec{j} = \sigma \cdot \vec{E} \quad \text{and} \quad \vec{B} = \mu \cdot \vec{H}$$

it is possible to derive a second order differential equation known as the **telegraph equation**:

$$\operatorname{rot} \operatorname{rot} \vec{F} + \sigma \mu \frac{\partial \vec{F}}{\partial t} + \mu \varepsilon \frac{\partial^2 \vec{F}}{\partial t^2} = 0$$

where ε is the permittivity of a dielectric medium,

σ is the electrical conductivity of a material,

μ is the permeability of a material and

\vec{F} is a placeholder which stands for either \vec{E} or \vec{H} .

If one assumes that the conductivity of the medium in which a wave propagates is very small ($\sigma \rightarrow 0$) and if one limits all signals to sinusoidal signals with an angular frequency ω , the so called **wave equation** can be derived:

$$\text{rot rot } \vec{F} - \omega^2 \mu \epsilon \vec{F} = 0$$

The simplest solution to this equation is known as a **plane wave propagating in loss-free homogenous space**. For this wave, the following condition applies:

- The vectors of the electric and magnetic field strength are perpendicular to each other and mutually also to the direction of propagation (see [Figure 4](#)).

Consequently the electric and magnetic field strengths are connected to each other via the so called **impedance of free space**:

$$E = Z_0 \cdot H \quad \text{with } Z_0 = 120\pi \Omega \approx 377 \Omega$$

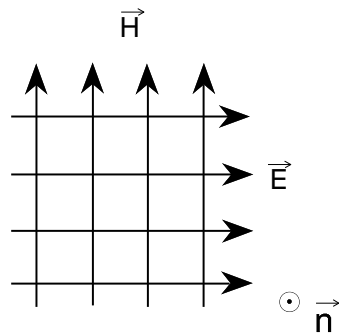

Figure 4: Plane wave description

There are two preconditions for the existence of plane waves:

1. **Far field conditions** must be reached.
2. **Free space conditions** are present.

Only if both of them are met, the assumption that the electric field strength drops with the factor $1/r$ over the distance r , can be made.

2.2 Wavelength

In linear media, any wave pattern can be described in terms of the independent propagation of sinusoidal components. The wavelength of a sinusoidal waveform travelling at constant speed is given by:

$$\lambda = \frac{v}{f} \quad \text{with } v = c_0 \approx 300\,000 \frac{\text{km}}{\text{s}}$$

The wavelength is a measure of the distance between repetitions of a shape feature such as peaks, troughs or zero-crossings.

2.3 Far Field Conditions

The distance from an antenna, where far field conditions are met, depends on the dimensions of the antenna in respect to the wave length. For smaller antennas (e.g. a half-wave dipole) the wave fronts radiated from the antenna become almost parallel at much closer distance compared to electrically large antennas. A good approximation for small antennas is that far field conditions are reached at:

$$r \approx 2 \cdot \lambda$$

For larger antennas (i.e. reflector antennas or array antennas) where the dimensions of the antenna (L) are significantly larger compared to the wave length ($L \gg \lambda$), the following approximation for the far field distance applies:

$$r \approx \frac{2L^2}{\lambda}$$

2.4 Free Space Conditions

Free space conditions require a direct line of sight between the two antennas involved. Consequently no obstacles must reach into the path between them. Furthermore in order to avoid the majority of effects caused by superposition of direct and reflected signals, it is necessary that the first Fresnel ellipsoid (see [Figure 5](#)) is completely free of obstacles:

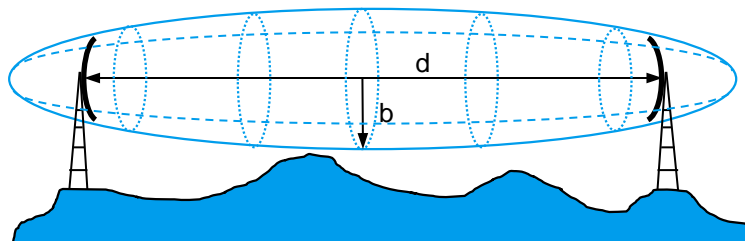

Figure 5: First Fresnel ellipsoid

The first Fresnel ellipsoid is defined as a rotational ellipsoid with the two antennas at its focal points. Within this ellipsoid the phase difference between two potential paths is less than half a wavelength.

The radius (b) at the center of the ellipsoid can be calculated based on the formula:

$$b = 17.32 \sqrt{\frac{d}{4f}}$$

where b is the radius in m,
d is the distance between RX and TX in km,
and f is the frequency in GHz.

2.5 Polarization

The polarization of an antenna is determined by the direction of the electric field \vec{E} . A distinction must be made between the following types of polarizations:

- **Linear polarization:** The \vec{E} field vector changes in magnitude only.
- **Circular polarization:** The magnitude of the \vec{E} field vector is constant, but the direction changes and rotates around the direction of propagation.
- **Elliptical polarization:** The magnitude and the direction of the \vec{E} field vector changes and its peak position can be described by an elliptical equation.

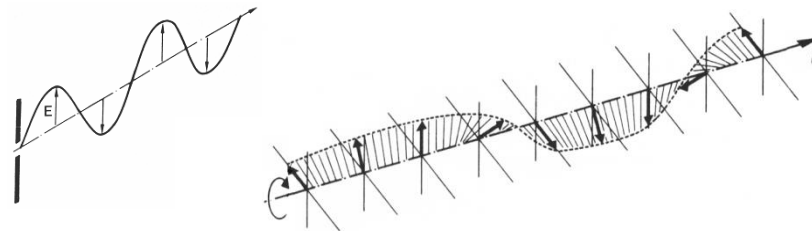

Figure 6: Linear (vertical) polarization and right-hand circular polarization

Polarization mismatch occurs when the polarization of the receiving antenna is not equal to the polarization of the incoming wave. Figure 7 gives an overview of the polarization mismatch and the related loss imposed on the received signal. Note that V means vertical, H horizontal, LHC left-hand circular and RHC right-hand circular polarization.

		Antenna polarization			
		↑	→	↻	↻
E vector of incoming signal	V ↑	0 dB	∞	3 dB	3 dB
	H →	∞	0 dB	3 dB	3 dB
	RHC ↻	3 dB	3 dB	0 dB	∞
	LHC ↻	3 dB	3 dB	∞	0 dB

Figure 7: Expected loss due to polarization mismatch

The losses that occur when trying to receive a linearly polarized signal with a circularly polarized antenna amounts to 3 dB (same vice versa) - this can usually be tolerated. Most critical is the case where the orthogonal antenna polarization is used, because the attenuation increases beyond all limits theoretically. In practice, most antennas have a limited polarization decoupling, so that the loss in reality will never reach infinity.

3 General Antenna Characteristics

As mentioned in the introduction, antennas have the function of converting one type of wave into another. The direction of energy conversion is of no importance for the operational principle or for the ease of understanding. The transmitting and the receiving antenna can therefore be looked at in the same way (reciprocity principle), and the parameters described in this chapter are equally valid for transmission and reception. This even applies if the parameters are in some cases measurable only for transmission or for reception or if their specification appears to be meaningful only for one of these modes. Active antennas are the only exception: being pure receiving antennas, they are non-reciprocal. Apart from that, a clear distinction between transmitting and receiving antennas must be made if, for example, the maximum transmitter power is to be taken into account. However, this is irrelevant to the characteristics and the principle of operation.

3.1 Radiation Density

The simplest imaginable antenna is the isotropic radiator, which does not exist in practice, but makes an excellent theoretical model. An isotropic radiator, which is a dimensionless point in space, generates waves with spherical wave fronts that are radiated uniformly in all directions. When the ideally matched transmitter power P_S is applied to it, then at distance r this gives rise to the **radiation density**:

$$S = \frac{P_S}{4\pi r^2}$$

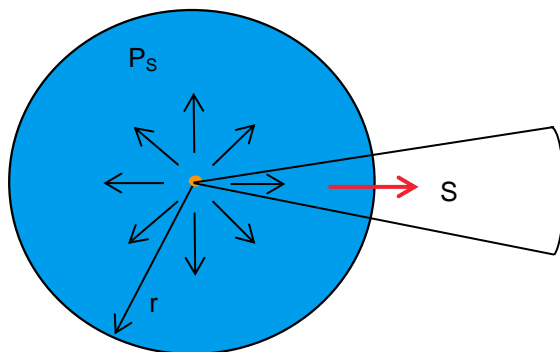

Figure 8: The isotropic radiator in homogenous space

The radiation density (often also known as the power density) can also be determined in the far field as the product of electric and magnetic field strength in accordance with

$$S = E \cdot H$$

3.2 Radiation Pattern

The three-dimensional radiation behavior of antennas is described by their radiation pattern (normally in the far field). As explained before, only an isotropic radiator would exhibit the same radiation in every spatial direction, but this radiator cannot be implemented for any specified polarization and is therefore mainly suitable as a model and comparison standard. Dipoles and monopoles possess directivity. An electrically short dipole in free space has a three-dimensional radiation pattern shown in [Figure 9](#) with nulls in the direction of the antenna's axis.

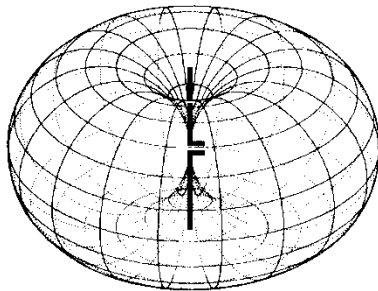

Figure 9: Three-dimensional radiation of a dipole antenna

While the radiation pattern is actually three-dimensional, it is common however to describe this behavior with two planar patterns, also called the principal plane patterns. They can be obtained from the spatial radiation characteristics by looking at a cut-plane - usually through the origin and the maximum of radiation. Spherical coordinates as shown in [Figure 10](#) are commonly used to describe a location in the three-dimensional space.

The **horizontal pattern** (see [Figure 11](#)) shows the field strength as a function of the azimuth angle ϕ with a fixed ϑ (usually $\vartheta = 90^\circ$).

The **vertical pattern** (see [Figure 12](#)) shows the field strength as a function of ϑ for a fixed ϕ (usually $\phi = \pm 90^\circ$ or $0^\circ/180^\circ$)

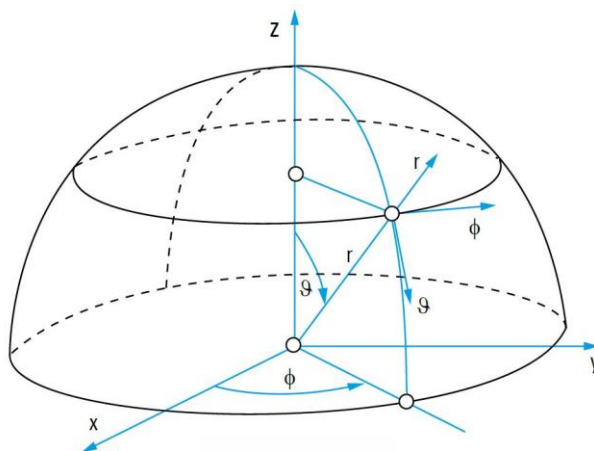

Figure 10: Explanation of spherical coordinates

Characterizing an antenna's radiation behavior with the two principle plane patterns is adequate for antennas with a well-behaved pattern - meaning that not much information is lost when just the two planes are shown.

In literature or datasheets the terms azimuth pattern or elevation pattern are also frequently found. The term **azimuth** describes the reference to "the horizon" or "the horizontal" whereas the term **elevation** describes the reference to "the vertical". If these two terms are used to describe antenna radiation patterns, they assume that during the measurement the antenna is mounted in the orientation in which it will be normally used.

Another common designation for the two principal plane patterns are **E-plane pattern** and **H-plane pattern**. They depend directly on the orientation of the antenna's radiators. Consequently they are not depending on the mounting orientation of the antenna.

Please note:

H-plane must not be mixed up with horizontal plane!

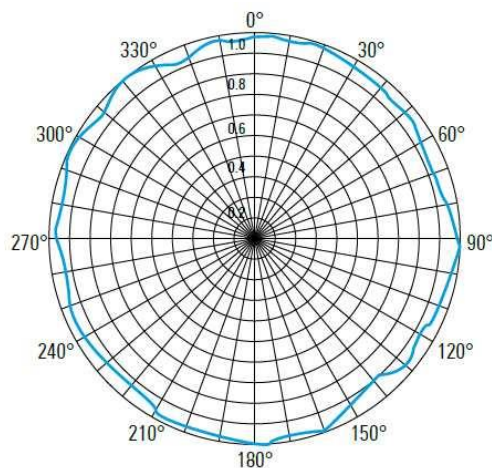

Figure 11: Horizontal pattern of a dipole antenna

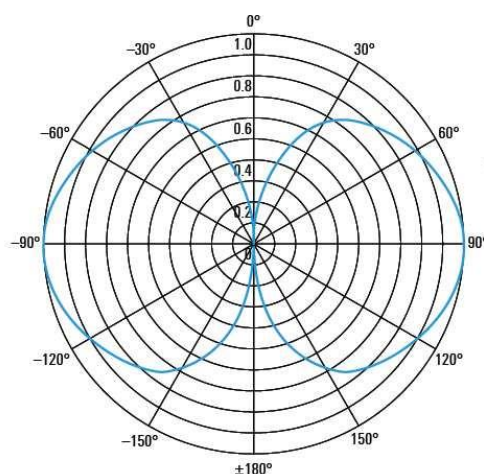

Figure 12: Vertical pattern of a dipole antenna

Usually antenna patterns are shown as plots in polar coordinates. This has the advantage that the radiation into all possible directions can quickly be visualized. In some occasions (i.e. for highly directive antennas) it can also be beneficial to plot the radiation pattern in Cartesian coordinates - because this reveals more details of the main beam and adjacent side lobes (see Figure 13).

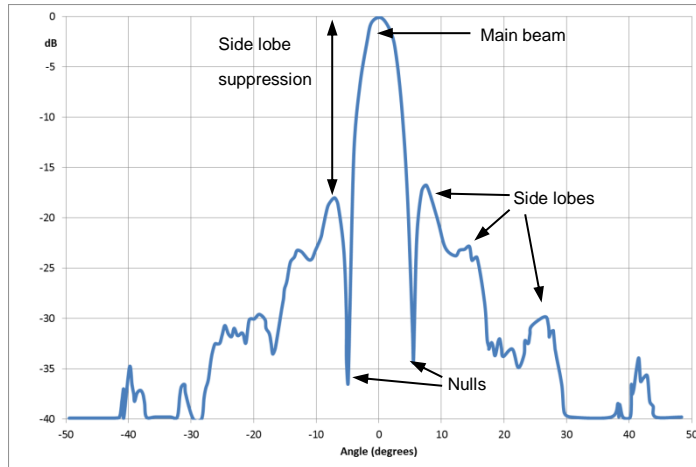

Figure 13: Radiation pattern in Cartesian coordinates

From the radiation pattern the following additional parameters can be derived (see Figure 14)

- The **side lobe suppression** (or side lobe level) is a measure of the relation between the main lobe and the highest side lobe.
- The **half-power beamwidth (HPBW)** is the angle between the two points in the main lobe of an antenna pattern that are down from the maximum by 3 dB. It is usually defined for both principal plane patterns.
- The **front-to-back ratio** specifies the level of radiation from the back of a directional antenna. It is the ratio of the peak gain in forward direction to the gain in the reverse (180°) direction. It is usually expressed in dB.

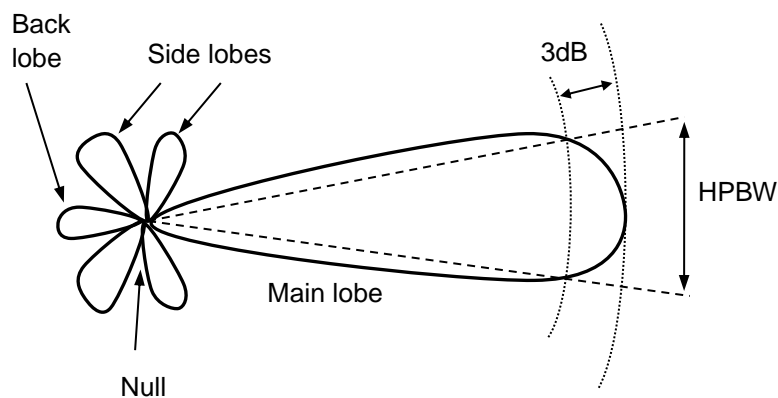

Figure 14: Further parameters in the radiation pattern

3.3 Directivity

The **directivity factor D** is defined as the ratio of the **radiation intensity** F_{\max} obtained in the main direction of radiation to the radiation intensity F_i that would be generated by a loss-free isotropic radiator with the same **radiated power** P_t . The radiation intensity can be replaced by the power density represented by the Poynting vector as shown below:

$$\vec{S} = \vec{E} \times \vec{H}$$

with \vec{S} perpendicular to \vec{E} and \vec{S} and \vec{E} perpendicular to \vec{H} in the far field.

The power density is measured at the same distance r from the antennas. The following thus applies:

$$D = \frac{F_{\max}}{F_i} \quad \text{where } F_i = \frac{P_t}{4\pi r^2}$$

3.4 Gain

Corresponding to the directivity factor, the gain G is the ratio of the radiation intensity F_{\max} obtained in the main direction of radiation to the radiation intensity F_{i0} , that would be generated by a loss-free isotropic radiator with the same **input power** P_{t0} .

$$G = \frac{F_{\max}}{F_{i0}} \quad \text{where } F_{i0} = \frac{P_{t0}}{4\pi r^2}$$

In contrast to the directivity factor, the **antenna efficiency** η is taken into account in the above equation since the following applies:

$$D = \eta \cdot G$$

For an antenna with efficiency $\eta = 100\%$, this means that gain and directivity are equal. In practice this is hardly the case, so the gain, which can be easily determined during measurements, is the parameter which is more frequently used.

Gain and directivity are often expressed in logarithmic form:

$$g/dB = 10 \log G \quad \text{or} \quad d/dB = 10 \log D$$

Contrary to common rules and standards, it is well established practice to indicate the reference with an additional letter after **dB**:

- **dB_i** refers to the isotropic radiator
- **dB_d** refers to the half-wave dipole

For example the following conversion applies: 0 dB_d \approx 2.15 dB_i.

3.5 Practical Gain

While the gain definition assumes ideal matching between the antenna and the connected cable and receiver or transmitter, in practice this is rarely the case. So what is measured in a non-ideally matched setup is called the **practical gain** of an antenna.

The gain can be determined from the practical gain with the following formula:

$$G = G_{pract} \frac{1}{1 - |r|^2}$$

where the amount of mismatch is expressed by the magnitude of the **reflection coefficient r** (see 3.9)

3.6 Effective Area

The effective area A_w of an antenna is a parameter specially defined for receiving antennas. It is a measure for the maximum received power P_r that an antenna can pick up from a plane wave of the power density S :

$$P_{r \max} = S \cdot A_w$$

Although the effective area of an antenna can well be conceived as a real area perpendicular to the direction of propagation of the incident wave, it is not necessarily identical with the geometrical area A_g of the antenna. The relationship between the effective and the geometrical areas is described by the **aperture efficiency q**

$$q = \frac{A_w}{A_g}$$

The effective area of an antenna can be converted to the gain and vice versa by means of the formula:

$$A_w = \frac{\lambda^2}{4\pi} G$$

3.7 Input Impedance

One of the most significant parameters of an antenna is its input impedance:

$$Z_{in} = R_{in} + jX_{in}$$

This is the impedance present at the antenna feed point. Its real part R_{in} can be split up into the **radiation resistance** R_R and the **loss resistance** R_L

$$R_{in} = R_R + R_L$$

It should be noted however that the radiation resistance, being the quotient of the radiated power and the square of the RMS value of the antenna current, is spatially dependent. This applies also to the antenna current itself. Consequently, when specifying the radiation resistance, its location on the antenna needs to be indicated.

Quite commonly the antenna feed point is specified, and equally often the current maximum. The two points coincide for some, but by no means for all types of antenna.

The imaginary part X_{in} of the input impedance disappears if the antenna is operated at **resonance**. Electrically very short linear antennas have capacitive impedance values ($X_{in} < 0$), whereas electrically too long linear antennas can be recognized by their inductive imaginary part ($X_{in} > 0$).

3.8 Nominal Impedance

The nominal impedance Z_n is a mere reference quantity. It is commonly specified as the characteristic impedance of the antenna cable, to which the antenna impedance must be matched (as a rule $Z_n = 50 \Omega$).

3.9 Impedance Matching and VSWR

If the impedance of an antenna is not equal to the impedance of the cable and/or the impedance of the transmitter, a certain discontinuity occurs.

The effect of this discontinuity is best described for the transmit case, where a part of the power is reflected and consequently does not reach the antenna (see [Figure 15](#).) However the same will happen with the received power from the antenna that does not fully reach the receiver due to mismatch caused by the same discontinuity.

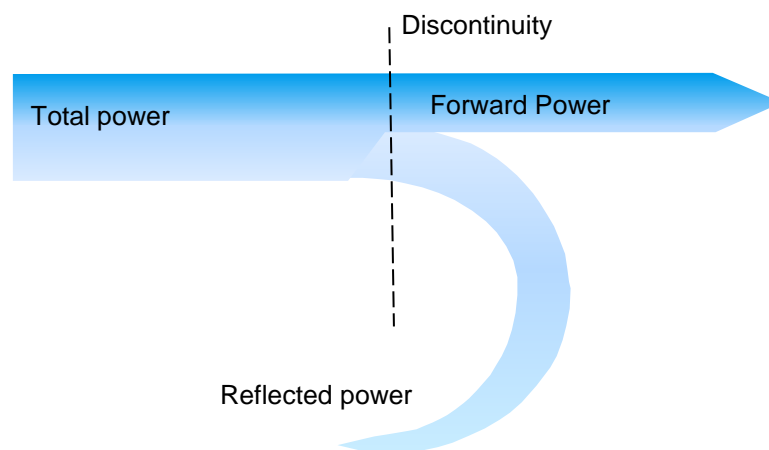

Figure 15: Forward and reflected power due to mismatch

The amount of reflected power can be calculated based on the equivalent circuit diagram of a transmit antenna (see Figure 16).

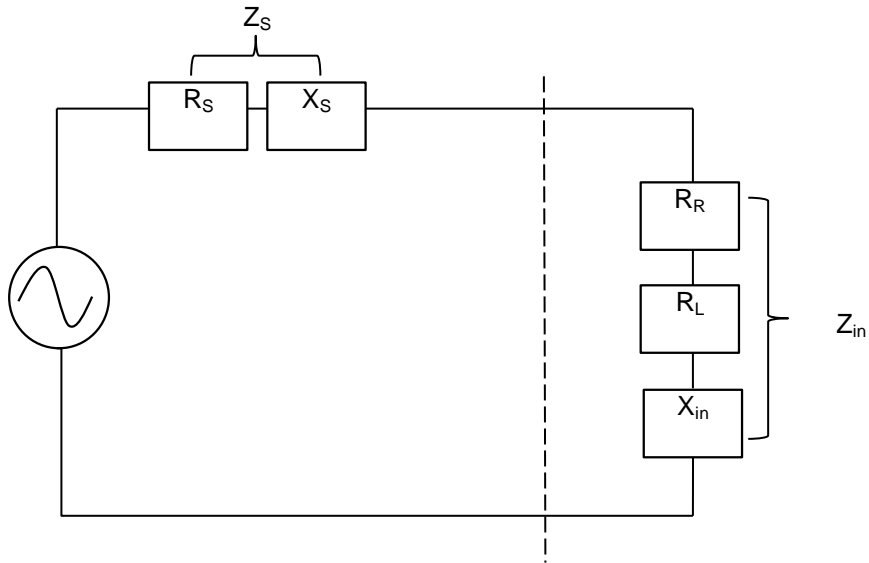

Figure 16: Equivalent circuit diagram of a transmit antenna

For optimum performance, the impedance of the transmitter (Z_S) must be matched to the antenna input impedance Z_{in} . According to the maximum power transfer theorem, maximum power can be transferred only if the impedance of the transmitter is a complex conjugate of the impedance of the antenna and vice versa. Thus the following condition for matching applies:

$$Z_{in} = Z_S^*$$

$$\text{where } Z_{in} = R_{in} + jX_{in} \text{ and } Z_S = R_S + jX_S$$

If the condition for matching is not satisfied, then some power may be reflected back and this leads to the creation of **standing waves**, which are characterized by a parameter called **Voltage Standing Wave Ratio (VSWR)**.

The VSWR is defined (as implicated by its name) as the ratio of the maximum and minimum voltages on a transmission line. However it is also possible to calculate VSWR from currents or power levels as the following formula shows:

$$s = \frac{V_{max}}{V_{min}} = \frac{I_{max}}{I_{min}} = \frac{|V_{forw}| + |V_{refl}|}{|V_{forw}| - |V_{refl}|} = \frac{\sqrt{P_{forw}} + \sqrt{P_{refl}}}{\sqrt{P_{forw}} - \sqrt{P_{refl}}}$$

Another parameter closely related to the VSWR is the **reflection coefficient r**. It is defined as the ratio of the amplitude of the reflected wave V_{refl} to the amplitude of the incident wave V_{forw} :

$$r = \frac{V_{refl}}{V_{forw}}$$

It is furthermore related to the VSWR by the following formula:

$$s = \frac{1 + |r|}{1 - |r|}$$

The **return loss** a_r derives from the reflection coefficient as a logarithmic measure:

$$a_r = -20 \log|r| = -20 \log\left(\frac{V_{refl}}{V_{forw}}\right) = -10 \log\left(\frac{P_{refl}}{P_{forw}}\right)$$

So there are in fact several physical parameters for describing the quality of impedance matching; these can simply be converted from one to the other as required.

For easy conversion please refer to the table below:

VSWR	r	ar	Reflected power
1.002	0.001	60 dB	
1.01	0.005	46 dB	
1.1	0.05	26 dB	0.2 %
1.2	0.1	20 dB	0.8 %
1.5	0.2	14 dB	4 %
2.0	0.33	9.5 dB	11.1 %
3.0	0.5	6 dB	25 %
5.0	0.67	3.5 dB	44.4 %

3.10 Antenna Factor

The antenna factor (often also called transducer factor or conversion factor) is defined as the ratio of electric field strength and the measured output voltage at its feed point.

$$K = \frac{\text{Electrical field strength}}{\text{Output voltage at } 50 \Omega}$$

It is used in receivers in order to display the field strength surrounding the antenna rather than the voltage level of the signal. Often it is more convenient to use the antenna factor in logarithmic form:

$$k = 20 \log K$$

Typical antenna factor values are usually specified in the antenna's documentation - either in a table or graphical format. If an antenna was calibrated the exact antenna factor values are listed in the antenna calibration document. The unit of the logarithmic form of the antenna factor is dB/m.

When the antenna factor is known, the field strength E surrounding the antenna can be easily calculated with the formula:

$$E / \text{dB}\mu\text{V}/\text{m} = U_{\text{RX}} / \text{dB}\mu\text{V} + k / \text{dB}/\text{m}$$

where U_{RX} is the receiver voltage level measured at its 50 Ω input.

For the sake of completeness it should be mentioned that to obtain a precise field strength measurement, the cable loss between the test antenna and the receiver has to be included:

$$E / \text{dB}\mu\text{V}/\text{m} = U_{\text{RX}} / \text{dB}\mu\text{V} + k / \text{dB}/\text{m} + \text{cable loss} / \text{dB}$$

While for field strength measurements the antenna factor is commonly used as the characterizing value of the antenna, the predominant terms in general antenna engineering are gain and directivity factor. Therefore, it often proves useful to know the relationship:

$$K = \frac{9.73}{\lambda \cdot \sqrt{G}}$$

in order to convert between antenna factor and practical gain, which is also given in logarithmic form as:

$$k = -29.8 \text{ dB} + 20 \log \left(\frac{f}{\text{MHz}} \right) - g$$

3.11 Bandwidth of an Antenna

The bandwidth of an antenna is defined as the range of usable frequencies within which the performance of the antenna with respect to some characteristics conforms to a specified standard.

The parameter most commonly taken into account here is the impedance match (i.e. $VSWR < 1.5$) - but other parameters like gain or side lobe suppression may serve as a bandwidth criteria here, too.

For **broadband antennas**, the ratio of the highest and lowest usable frequencies is determined. A ratio of 2:1 is called an octave - a ratio of 10:1 is a decade.

$$BW = \frac{f_H}{f_L}$$

where f_H is the highest usable frequency and f_L is the lowest usable frequency.

An antenna is said to be broadband when BW is equal or greater than 2.

There exists also a different definition of bandwidth which is valid only for **narrowband antennas**:

$$BW \text{ (in \%)} = \left(\frac{f_H - f_L}{f_C} \right) \cdot 100$$

where f_C is the center frequency.

Values here can range from 0 to 200% - in practice this definition is only used up to about 100%.

4 Basic Characteristics of Selected Antennas

4.1 Half-wave Dipole

Dipole antennas are the most fundamental form of antenna that can be implemented. The best known example is the tuned (half-wave) dipole.

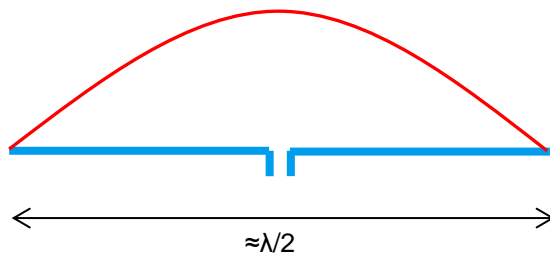

Figure 17: Half-wave dipole

Its length is somewhat less than half a wavelength and its input impedance at resonance is between $50\ \Omega$ and $70\ \Omega$ depending on its length/diameter ratio, so that a feed cable with a common nominal impedance can easily be connected. The current distribution on the dipole (shown by the red line in Figure 17) can be assumed to be sinusoidal in good approximation. Its three-dimensional radiation pattern has already been shown in 3.2 (see Figure 9). The radiation pattern in the E-plane, which is a reference plane along which the dipole axis lies, looks like the number 8 (see Figure 12), while the radiation pattern in planes perpendicular to its axis (H-plane) is uniform.

The name "half-wave dipole" indicates that this form of antenna can be constructed and used for one frequency only. However, experience shows that dipoles can actually be used for receiving purposes for a wider frequency range. It would be possible to conclude from this that half-wave dipoles could be used at least as test antennas, even far from their resonance frequency. When used for broadband purposes, however, conventional dipoles experience the following significant problems in practice:

- The antenna input impedance strongly depends on the antenna's length to wavelength ratio (see Figure 18), so that when operated far from the half-wave resonance frequency very significant matching problems occur. This is particularly true for a **thin** dipole, where the ratio of length (l) to diameter (d) is large. If this ratio is decreased, the amount of mismatch will be reduced. Some possible shapes for such **thick dipoles** are shown in Figure 19.

When matching the impedance of the dipole to the impedance of the feed cable, it also needs to be taken into account that a balanced antenna is usually connected to an unbalanced (or coaxial) cable by means of a **balun**. Balun is a contrived word composed of "balanced" and "unbalanced". It is a device that helps effecting the before mentioned transition. Without a balun, skin currents form on the outer conductor of the coaxial cable which can cause strong electromagnetic interference or significantly alter the radiation pattern of the antenna.

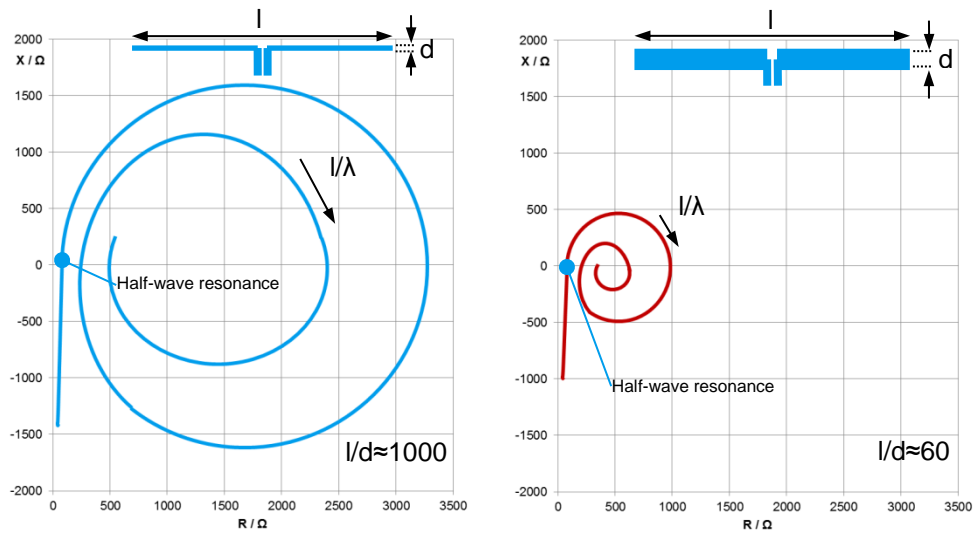

Figure 18: Input impedance of a dipole with different l/d ratios

In order to save materials and particularly weight, broadband dipoles are often designed in the form of a cage. Another commonly used test antenna is the biconical antenna shown in the very right.

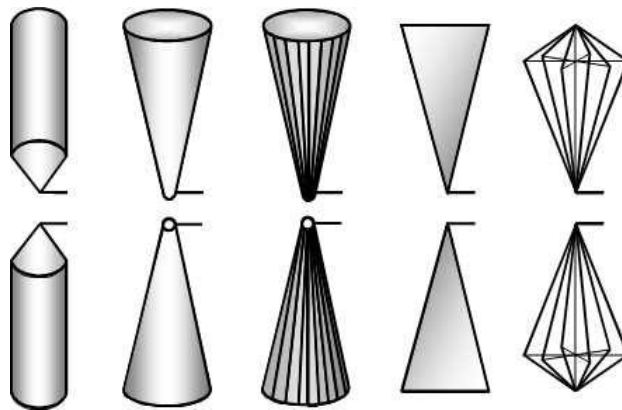

Figure 19: Possible shapes of broadband dipoles

- Above the full-wave resonance, even the radiation pattern changes as a function of the antenna length to wavelength ratio to such an extent (see Figure 20) that it is no longer possible to clearly determine the main direction of radiation or the gain, for example. This effect of "splitting up the radiation pattern" is caused by the non-ideal current distribution on the dipole when the length to wavelength ratio becomes too large. One option to avoid this is to design the antenna rods to function as telescopic elements, so that the antenna length can be varied to match the operating frequency. The dipole can then be operated at resonance at every frequency to which it is set. However this is very often not possible in practice, as the length must be changed whenever the frequency is changed.

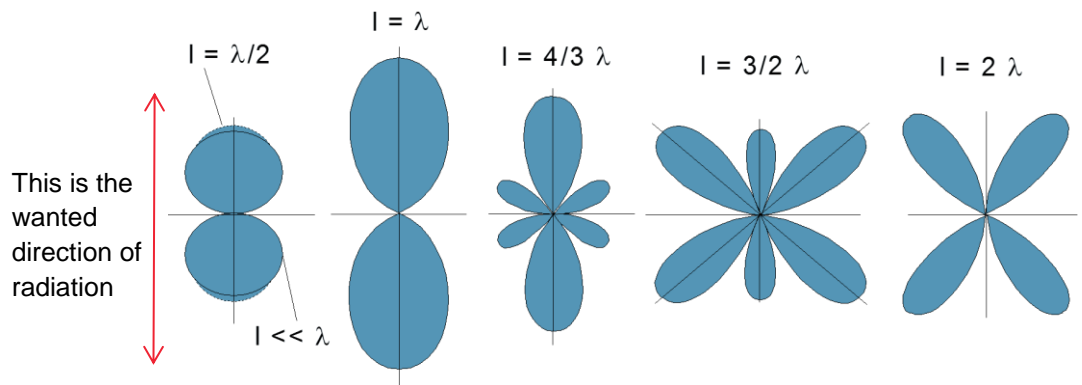

Figure 20: Dipole radiation pattern depending on length/wavelength ratio

Another more practical solution is to alter the current distribution on the antenna (for instance by reactive elements, resonant circuits or ferrite rings) in such a way that at higher frequencies only part of the antenna is activated. This keeps the ratio of wavelength to antenna length almost constant even though the frequency may vary. Electrically this solution is more or less the same as the telescopic antenna described before, but with no need for the user to go to any effort or expense.

4.2 Monopole Antenna

The operating principle of rod antennas (or monopoles) is based on the fact that the current distribution on an antenna structure that is only a quarter wavelength long is identical to that on a half-wave dipole (see Figure 17) if the antenna element "missing" from the dipole is replaced by a highly conducting surface. As a result of this reflection principle (see Figure 21), vertical quarter-wave antennas on conducting ground have basically the same radiation pattern as half-wave dipole antennas. There is of course no radiation into the shadowed half of the space. The input impedance is half that of a dipole, exhibiting values between approx. 30Ω and 40Ω .

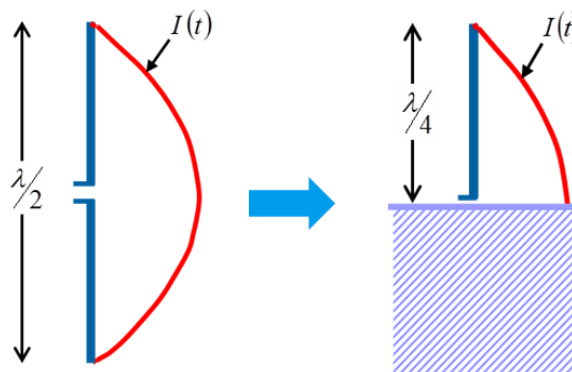

Figure 21: From a dipole to a monopole antenna

The conducting surface on which the monopole is erected plays an important part in enabling the reflection principle to take effect. Even on reasonably conducting ground (such as a field of wet grass) and particularly on poorly conducting ground (dry sand) it is usual and helpful to put out a ground net of wires (commonly also called radials).

Figure 22 shows the influence of ground conductivity on the vertical pattern of a monopole antenna:

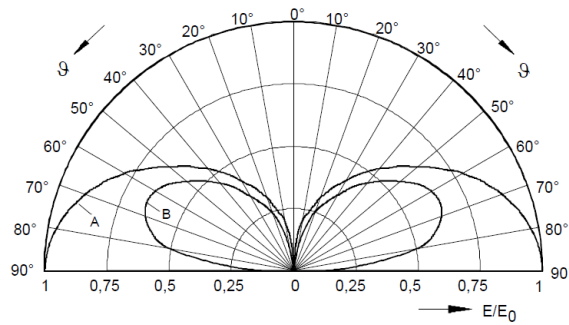

Figure 22: Vertical pattern of a monopole for perfectly conducting ground (A) and poor ground (B)

A special form of a monopole antenna is the so called groundplane antenna (see Figure 23). It is characterized by several wires or rods (known as radials) which are arranged in a radial configuration from the feed point under a certain angle. Typically an angle of approx. 135° to the quarter wave monopole is used in order to increase the feed point resistance to a value of approx. 50Ω which can easily be matched to commonly used coaxial cables.

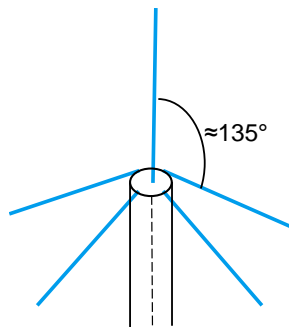

Figure 23: Groundplane Antenna

Groundplane antennas are used as vertically polarized omnidirectional antennas even in the VHF/UHF frequency range.

4.3 Directional Antennas

It has already been mentioned that ideal omnidirectional antennas cannot be produced in reality. Nonetheless only antennas that focus their radiated power in a particular spatial direction can properly be called directional antennas. At an equivalent transmit power, they significantly improve the signal-to-noise ratio, but must be aligned on the distant station so that in many cases a rotation facility has to be used. For directional antennas the parameters gain, directivity and all values associated with the radiation pattern, like front-to-back ratio, side-lobe suppression or half-power beamwidth as already discussed in 3.2 give an overview about how much the radiated energy is focused into a certain direction.

The simplest form of a directional antenna is a setup of two monopole antennas at a predefined distance, which are fed with different phase (see Figure 24).

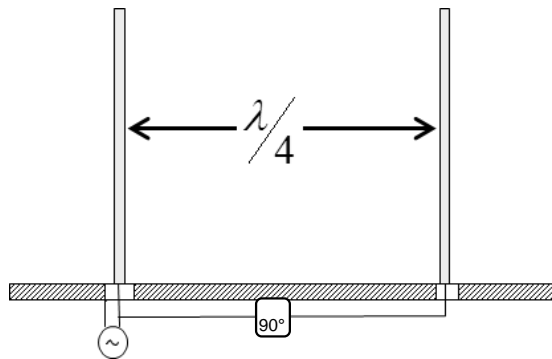

Figure 24: Principle of a directional antenna

In the example a distance of a quarter wavelength and a phase difference of 90° have been chosen, resulting in a cardioid shaped radiation pattern (see Figure 25) when the far field strengths generated by the two individual antennas are added.

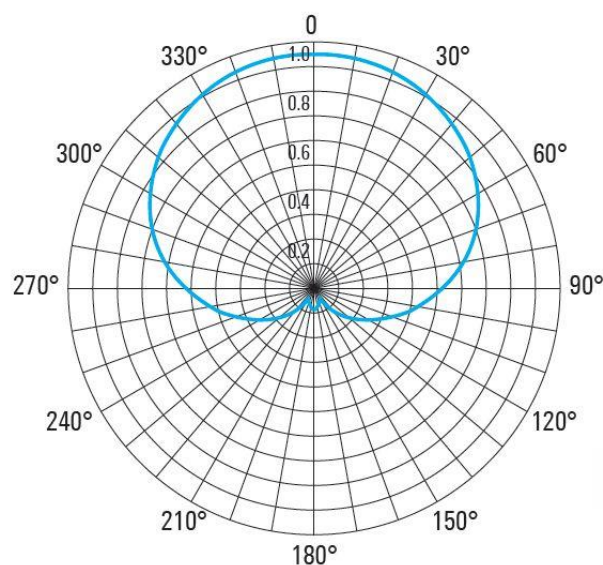

Figure 25: Cardioid shaped radiation pattern

Even though this configuration does not produce strongly focused radiation, it however exhibits a sharply defined null towards the backside which can effectively be used to suppress interfering signals.

By superimposing the diagrams obtained by combining two or several radiators arranged at defined distances and with defined phase shifts, directional patterns can be generated whose directivity is limited mainly by the available space to setup the number of required radiators.

Instead of feeding the radiators via cables as shown in [Figure 24](#), the principle of radiation coupling is mostly applied in practice, with only one radiator being fed from the cable and the remaining elements activated by this radiator. **Yagi-Uda antennas**, which are commonly used for the reception of TV and VHF sound broadcast signals, have typically between 4 and 30 elements and yield gain values of 10 dB and more.

The possibility of changing the direction of the main beam of a highly directive antenna by purely electronic means is utilized to an increasing extent also with antenna arrays for very high frequencies (e.g. for satellite radio services). The antennas used are referred to as **planar antennas** and mostly consist of a dipole curtain which, in contrast to curtain antennas, is installed in front of a conductive plane. This array can also be implemented by etching the radiators as tracks into a printed circuit board (microstrip antenna). In this way, even large arrays of antennas can be implemented for the microwave frequency range with high precision and efficiency.

4.4 Log-Periodic Dipole Antenna

A special type of directional antenna is the log-periodic dipole antenna (LPDA), where beam shaping is performed by means of several driven elements. The LPDA is made up of a number of parallel dipoles of increasing lengths and spacing (see [Figure 26](#)). Each dipole is fed out of phase to the element on either side by a common feed line. The angle α formed by the lines joining the dipole ends and by the longitudinal axis of the antenna remains constant, as well as the graduation factor τ which is equal to the ratio of the lengths of neighboring elements and their spacing:

$$\tau = \frac{l_{n+1}}{l_n} = \frac{d_{n+1}}{d_n} = \text{const}$$

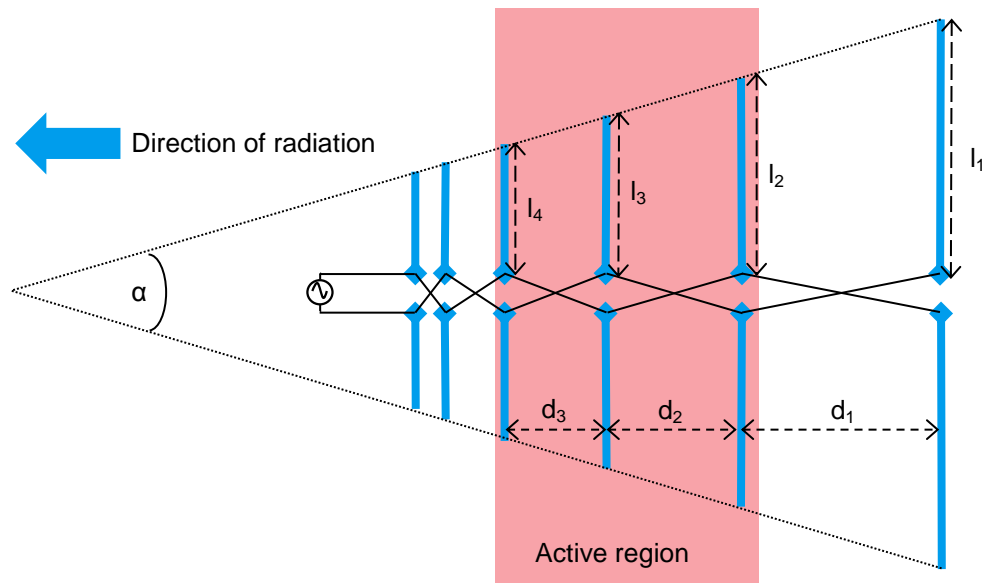

Figure 26: Log-periodic dipole antenna

This antenna type is characterized by its **active and passive regions**. The antenna is fed starting at the front (i.e. with the shortest dipole). The electromagnetic wave passes along the feed line and all dipoles that are markedly shorter than half a wavelength will not contribute to the radiation. The dipoles in the order of half a wavelength are brought into resonance and form the **active region**, which radiates the electromagnetic wave back into the direction of the shorter dipoles. This means that the longer dipoles located behind this active region are not reached by the electromagnetic wave at all. The active region usually comprises of 3 to 5 dipoles and its location obviously varies with frequency. The lengths of the shortest and longest dipoles of an LPDA determine the maximum and minimum frequencies at which it can be used.

Due to the fact that at a certain frequency only some of the dipoles contribute to the radiation, the directivity (and therefore also the gain) that can be achieved with LPDAs is relatively small in relation to the overall size of the antenna. However, the advantage of the LPDA is its large bandwidth which is - in theory - only limited by physical constraints.

The radiation pattern, of an LPDA is almost constant over the entire operating frequency range. In the H-plane it exhibits a half-power beamwidth of approx. 120° , while the E-plane pattern is typically 60° to 80° wide. The beamwidth in the H-plane can be reduced to values of approx. 65° by stacking two LPDAs in V-shape. (see [Figure 27](#))

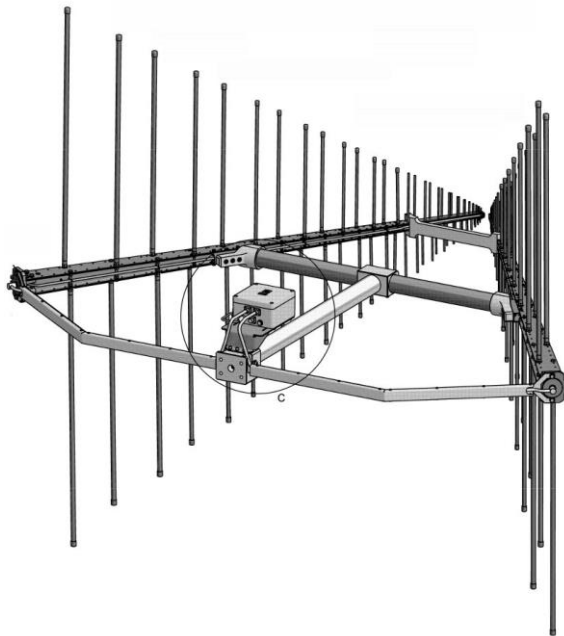

Figure 27: Example of a V-stacked LPDA

V-stacked LPDA antennas have E- and H-plane patterns with very similar half power beamwidths (see Figure 28). Additionally they feature approx. 1.5 dB more gain compared to a normal LPDA.

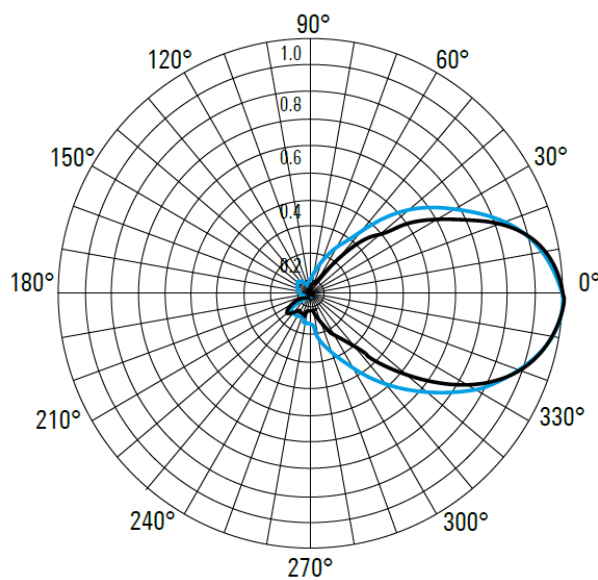

Figure 28: Radiation pattern of a V-stacked LPDA - E-plane (black), H-plane (blue)

4.5 Active Antennas

Active antennas represent another possible way of implementing compact broadband antennas. They are based on the idea that drastically shortening the dipole length of an antenna will result in a corresponding reduction in output levels for both the useful signal P_S and the noise P_N . As a consequence, the signal-to-noise ratio (S/N), which is the sole indicator of reception quality, stays constant within fairly wide limits as can be seen in Figure 29.

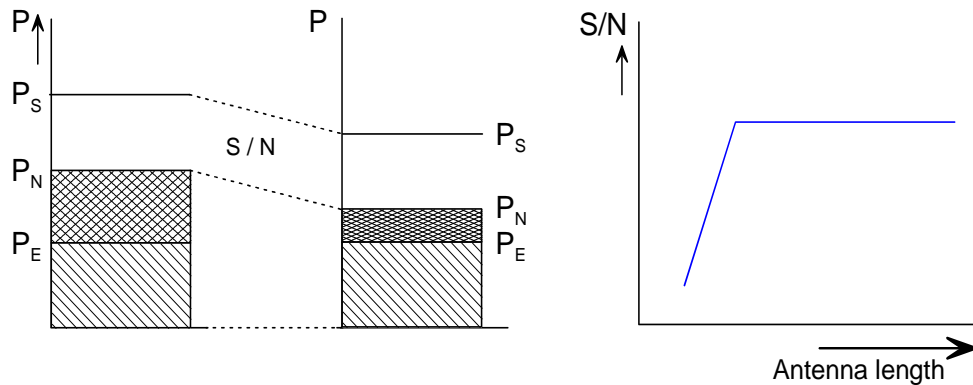

Figure 29: Active antenna basic principle

The S/N will get affected only at a point where the level of the external noise P_N falls below the receiver noise P_E which is influenced only by the technical parameters of the receiver itself.

In chapter 3 (see Figure 18) it was already shown that shortening the radiator is associated with extreme changes in the impedance. For active rod or dipole antennas this is compensated by feeding the signal voltage on the terminals of the antenna directly to a very high-impedance active component (usually a field effect transistor) which acts as an impedance transformer and also commonly amplifies at the same time. Active antennas are therefore by definition antennas in which an active element is attached directly to the electrically short radiators (i.e. of a dipole as shown in Figure 30), and are not to be confused with systems in which the output signal of a passive antenna is looped through a preamplifier, for example.

Active antennas can obviously be used **for reception only**.

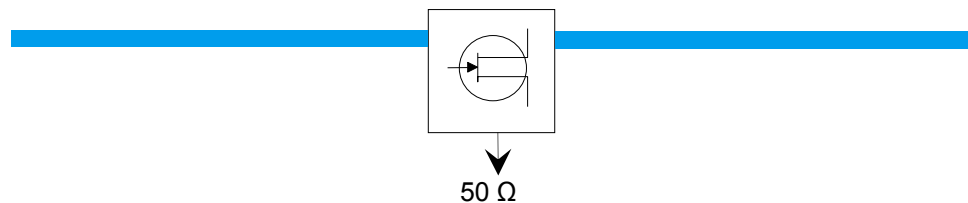

Figure 30: Active dipole antenna in principle

An advantage of using active antennas is the fact that usually their radiation patterns are no longer a function of frequency because they utilize elements of electrically short length. By carefully tuning the active circuitry to the antenna geometry and by using other measures, it is also possible to ensure that the antenna factor is largely independent of frequency, so that field strength measurements can be carried out very easily.

Active antennas are mainly but not exclusively used for lower frequencies (up to about 200 MHz) at which the noise floor in the atmosphere is very high. Due to their extreme broadband characteristics, active antennas are being increasingly used also in the higher frequency ranges.

One of their biggest advantages is the reduced size requirement. For example an active rod antenna that covers HF and also part of the LF frequency range can be built with a radiator as short as approx. 1m, while a passive antenna for a comparable frequency range easily measures ten times this value.

When an active antenna is designed, the engineer needs to cope with two slightly contradictory aims:

- The active antenna should achieve maximum sensitivity in respect to the expected external noise. Consequently the designer will select the active devices for optimum noise figure and noise match.
- The active antenna should have good protection against interfering strong signals - no matter if they are generated internally or externally of the active antenna circuitry. Therefore the designer will select active devices with high intercept point values (IP2 and IP3).

Unfortunately it is not possible to reach both aims simultaneously and the margin between them is called the **dynamic range**. Active antenna will always have a limited dynamic range, which may render their usage difficult in close vicinity of strong transmitters or at locations where high field strength values exist due to other reasons.

In summary, active antennas have the following advantages and disadvantages

Advantage	Disadvantage
Smaller than comparable passive antennas	Can't be used for transmitting
Wider bandwidth than comparable passive antennas	More susceptible to interference if incorrectly installed
Generally frequency independent radiation pattern	Have less dynamic range
Can be installed relatively close to each other	Can't be installed in an interfered environment
Highly suitable as broadband test antennas	Must be carefully balanced

Care must be taken, when the gain of an active antenna is specified. There are two definitions to know in this context:

The **electronic gain** G_T is the ratio of the received power into the nominal resistance and the maximum received power which can be extracted from the field with an antenna of equal directional characteristics.

The **practical gain** G_{pract} is the ratio of received power into the nominal resistance P_r and the received power of a loss-free omnidirectional reference antenna (isotropic radiator) P_{ri} .

$$G_{pract} = \frac{P_r}{P_{ri}} = D \cdot G_T$$

Consequently, the gain alone does not allow drawing any conclusions about the radiation pattern of the active antenna or its **field strength sensitivity**.

The field strength sensitivity values are usually specified in the documentation of the antenna. In order to have comparable results the bandwidth and the achieved signal-to-noise ratio (S/N) must always be given in conjunction with the minimum field strength values that can be detected (see [Figure 31](#)).

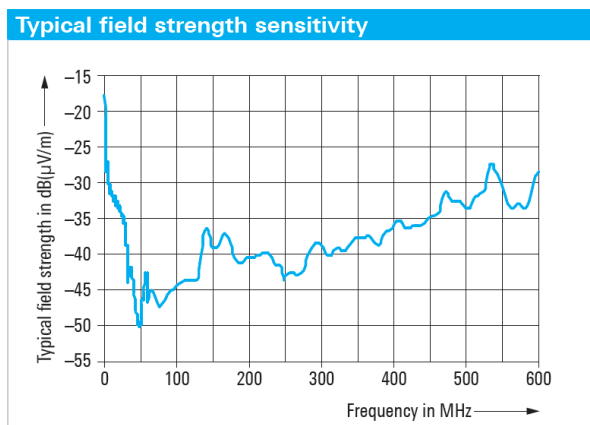

At antenna output (measurement bandwidth $\Delta f = 1$ Hz; S/N = 0 dB).

Figure 31: Field strength sensitivity specification of an active antenna

5 Appendix

5.1 References

References and recommended further reading		
Author	Title	Publisher
Balanis	Antenna Theory	John Wiley & Sons
Beckmann	Die Ausbreitung der elektromagnetischen Wellen (The propagation of Electromagnetic Waves)	Beckmann
Braun	Planung und Berechnung von Kurzwellenverbindungen (The Planning and Calculation of Shortwave Links)	Siemens
Chatterjee	Antenna Theory and Practice	John Wiley & Sons
Collin	Antennas and Radiowave Propagation	McGraw-Hill
Davies	Ionospheric Radio	Peregrinus
Dombrowski	Antennen (Antennas)	Porta München Technik Berlin
Grosskopf	Wellenausbreitung (2 volumes) (Wave Propagation)	Hochschultaschenbücher
Heilmann	Antennen (3 volumes) (Antennas)	Hochschultaschenbücher
Hock/Pauli	Antennentechnik (Antenna Engineering)	Expert
Jasik	Antennas	McGraw-Hill
Kraus	Antennas	McGraw-Hill
Lee	Mobile Communications Design Fundamentals	Howard W. Sams
Lee	Mobile Cellular Telecommunication Systems	McGraw-Hill
Maslin	HF Communications	Pitman
Meinke/Gundlach	Taschenbuch der Hochfrequenztechnik (Manual of High Frequency Engineering)	Springer
Reithofer	Praxis der Mikrowellenantennen (Microwave Antenna Practice)	UKW-Berichte
Rohner	Antenna Basics	Rohde & Schwarz internal
Rothammel	Antennenbuch (The Antenna Book)	Franckh-Kosmos
Spindler	Das große Antennenbuch (The Big Book of Antennas)	Franzis
Stirner	Antennen (3 volumes) (Antennas)	Hüthig
Wiesner	Fernschreiben und Datenübertragung auf Kurzwellen (Shortwave Telephony and Data Transmission)	Siemens
Zuht	Elektromagnetische Strahlungsfelder (Electromagnetic Radiation Fields)	Springer

About Rohde & Schwarz

Rohde & Schwarz is an independent group of companies specializing in electronics. It is a leading supplier of solutions in the fields of test and measurement, broadcasting, radiomonitoring and radiolocation, as well as secure communications. Established more than 75 years ago, Rohde & Schwarz has a global presence and a dedicated service network in over 70 countries. Company headquarters are in Munich, Germany.

Regional contact

Europe, Africa, Middle East
+49 89 4129 12345
customersupport@rohde-schwarz.com

North America
1-888-TEST-RSA (1-888-837-8772)
customer.support@rsa.rohde-schwarz.com

Latin America
+1-410-910-7988
customersupport.la@rohde-schwarz.com

Asia/Pacific
+65 65 13 04 88
customersupport.asia@rohde-schwarz.com

China
+86-800-810-8228 /+86-400-650-5896
customersupport.china@rohde-schwarz.com

Environmental commitment

- Energy-efficient products
- Continuous improvement in environmental sustainability
- ISO 14001-certified environmental management system



This white paper and the supplied programs may only be used subject to the conditions of use set forth in the download area of the Rohde & Schwarz website.

R&S® is a registered trademark of Rohde & Schwarz GmbH & Co. KG; Trade names are trademarks of the owners.

Rohde & Schwarz GmbH & Co. KG
Mühlhofstraße 15 | D - 81671 München
Phone + 49 89 4129 - 0 | Fax + 49 89 4129 - 13777

www.rohde-schwarz.com